

New Orleans Block Ice Shaver

Instruction Manual

Model #1087

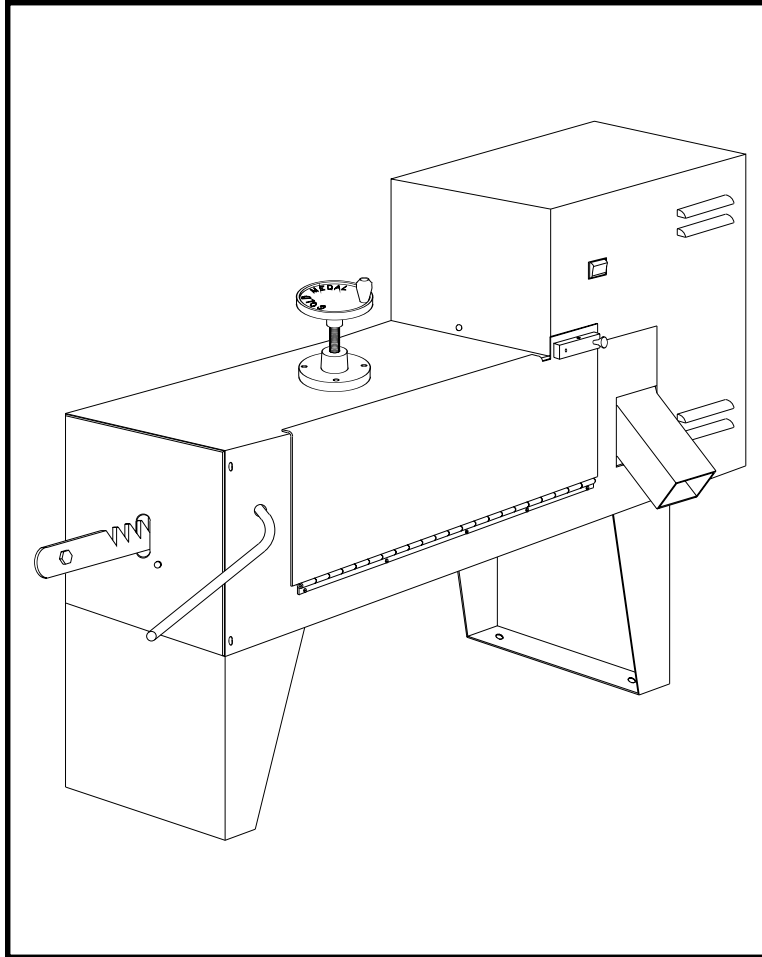



 **GOLD MEDAL®**

FUNFOOD EQUIPMENT & SUPPLIES

Cincinnati, OH 45241-4087 USA

SAFETY PRECAUTIONS

	⚠ CAUTION
	This equipment is designed and sold for commercial use only. This equipment is not to be used by the consumer in home use. Do not allow direct contact of this equipment by the public when used in food service locations. Only personnel trained and experienced in the equipment operation may operate this equipment. Carefully read all installation instructions before operating the equipment.

	⚠ WARNING
	Always wear safety glasses when servicing this equipment.

	⚠ WARNING
	Never put your fingers or any object into the shaver body while the motor is running. Serious injury may occur. <i>(Gold Medal Products does not assume any liability for injury due to careless handling and/or reckless operation of this equipment.)</i>

	⚠ WARNING
	Any alterations to this equipment will void the warranty and may cause a dangerous situation. NEVER make alterations to the equipment.

	⚠ DANGER
	Machine must be properly grounded to prevent electrical shock to personnel. Do NOT immerse the equipment in water. Always unplug the equipment before cleaning or servicing.

NOTE

The information, specifications and illustrations contained in this manual represent the latest data available at time of publication. Right is reserved to make changes as required at the discretion of Gold Medal Products Company without notice.

GENERAL SAFETY OPERATING TIPS WHEN USING A FOOTSWITCH

	⚠ CAUTION
	Failure to use footswitch safely could result in personal injury. Footswitch should only be used where adequate guards or other safety devices are in place for those applications where the use of a footswitch could cause personal injury.

	⚠ DANGER
	Always use a grounded plug or cable. Do not cut off the ground prong and be sure to ground the footswitch with the ground screw provided. Do NOT immerse the equipment in water. Unplug your machine before servicing.

Follow the appropriate wiring and safety requirements as set forth in the American National Standards Institute (ANSI) and National Electrical Code (NEC) or other appropriate standards.

Use proper electrical circuits and circuit protection when wiring footswitch.

Disconnect power before servicing.

Do not leave footswitch out in aisles or in areas where they can be inadvertently stepped on.

Do not allow cord to rest on floor or in areas where it can be a tripping hazard or can be abused by heavy traffic.

Do not leave footswitch accessible to inadvertent operation when left unattended or when not being used.

Do not bypass any machine or equipment safety features with this footswitch.

Replace damaged cord immediately.

It is the responsibility of the user to determine the suitability of a foot control for the intended use.

It is the responsibility of the user to comply with all federal, state and local safety and health regulations.

SPECIAL FEATURES

1. Model #1087 uses block ice approximately 5" x 5" x 12" long.
2. Snow texture can be adjusted easily with varying the feed pressure applied to pusher lever arm.
3. Cutter Head is equipped with three blades for rapid shaving.
4. Safety switch is installed to prevent operation of cutter head while shaver door is in an open position.

SPECIFICATIONS

Dimensions: 28" high x 34" wide x 15" deep.
Weight: Approximately 110 pounds, 140 pounds shipping weight.
Motor: $\frac{3}{4}$ horse power, 110 volts, 11.6 amps, 1725 r.p.m., 60Hz.
Requires a 15 amp dedicated power source.
Capacity: Approximately 12 pounds of ice.
Accessories: Foot switch.
Stainless Steel cabinetry for ease of cleaning and strength.

INSTALLATION



1. Be sure to connect electrical plug to a grounded receptacle.
2. Be sure unit is on table that is sturdy and can withstand accidental dripping of water and ice.

USING YOUR MACHINE

1. Allow ice to soften before use. Ice, when properly softened, will appear clear and not frosted.
2. Lower cover door and load ice block and set pressure plate by turning the top hand wheel. After pressure is set close the door. Hold serving cup directly below ice chute and engage power switch. With left hand on pressure lever, force ice into shaver head. The amount of pressure applied at this point will determine the fineness or coarseness of the shaved ice.
3. The last inch or so of the block of ice being shaved will typically break apart.

NOTE: Failure to close door will cause machine not to operate.

CLEANING INSTRUCTIONS

	 DANGER
	Do NOT immerse the equipment in water. Unplug your machine before servicing.

A regular cleaning routine will enable you to maintain a clean and attractive Block Shaver. It is recommended that the shaver be cleaned at the end of each day of operation.

1. The cabinetry should be cleaned both inside and out with hot, soapy water.
2. Use a non-toxic cleaner, and dry all surfaces with a soft cloth to avoid scratching.
2. Follow the sanitizing procedures for your area.

MAINTENANCE INSTRUCTIONS

	⚠ CAUTION
	<p>THE FOLLOWING SECTIONS OF THIS MANUAL ARE INTENDED ONLY FOR QUALIFIED SERVICE PERSONNEL WHO ARE FAMILIAR WITH ELECTRICAL EQUIPMENT. THESE ARE NOT INTENDED FOR THE OPERATOR.</p>

	⚠ WARNING
	<p>Adequate eye protection must be used when servicing this equipment to prevent the possibility of injury.</p>

	⚠ DANGER
	<p>Do NOT immerse the equipment in water. Unplug your machine before servicing.</p>

INSTALLING NEW SHAVER BLADES

Inspect your equipment before replacing the blades. Use a flashlight to examine the blades in the shaver body. If the blades appear to be nicked or bent, they should be replaced. Follow this procedure:

1. Unplug the main power supply cord from the electrical outlet.
2. Remove the belt guard cover by removing the 1/4–20" pan head screw in the left side and loosen the four #10–32 screws both front and back. The cover can now be rotated over and upside down and sit upside down on top of the shaver cabinet, leaving electrical wiring intact.
3. Remove the drive belt from the drive motor and cutter head. This can be done using a large screw driver to wedge and rotate the belt out of the pulley groove.
4. Remove the four wing nuts securing the cutter into place. The cutter head can now be removed.
5. Remove 8" diameter pulley by loosening 1/4–20" set screw and pull pulley from cutter head shaft.
6. The cutter head can now be pulled from the cutter head housing.
7. See blade set diagram for blade set information.
8. Reassemble in reverse order.

NOTE: Replace the shims that were between the motor base and the mounting surface. The motor shaft must be in alignment with the shaver drive shaft. Misalignment will cause the motor coupling to wear rapidly.

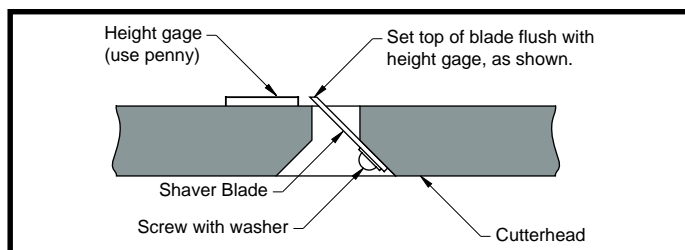

ORDERING SPARE PARTS

1. Identify the desired part by checking it against the photos, illustrations, and/or the parts list.
2. When ordering, please include part number, part name, and quantity desired.
3. Please include your model name and machine serial number (located on the machine name-plate) with your order.
4. Address all parts orders to:

**Gold Medal Products Co.
Attn: Parts Department
10700 Medallion Drive
Cincinnati, Ohio 45241-4807**

or, place orders at:

**(513) 769-7676
Fax: (513) 769-8500
E-mail: goldme19@eos.net**

BLOCK SHAVER ASSEMBLY

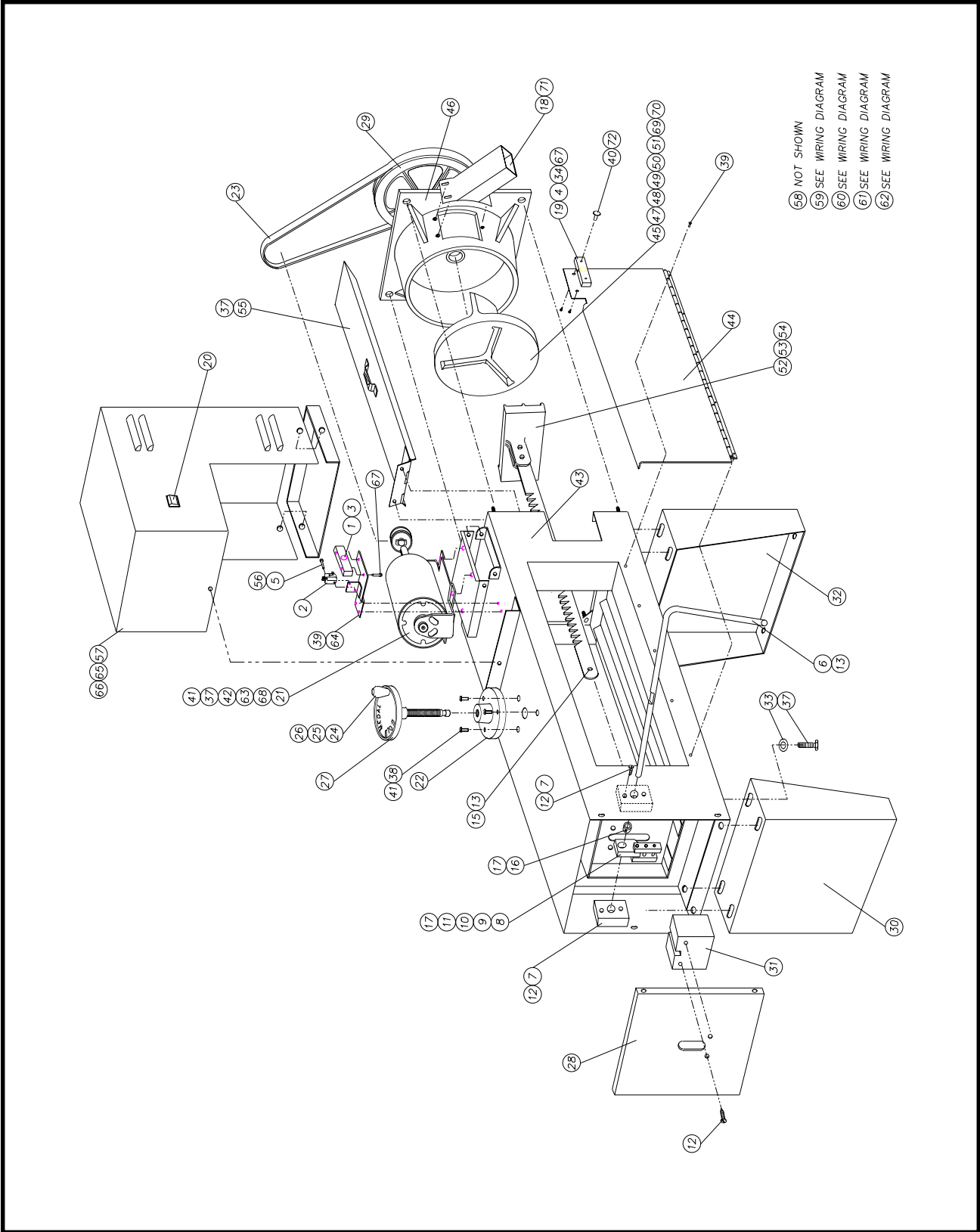

PARTS LIST – BLOCK SHAVER

Item No.	Part No.	Description
1	12078	1/2 x 1/2" Magnet
2	12116	Door Safety Switch
3	12135	Mount Block-magnet
4	12165	#8-32 x 1/8" Set Screw S.S.
5	12186	#4-40 x 3/4" Rd. Slit. #18-8 M/S
6	12564	Push Lever
7	12562	Support, Feed Lever
8	12563	Ratchet Mech. A
9	12256	Ratchet Mech. B
10	12460	3/16 x 1" Spring Pin
11	12462	1/4 x 1" Spring Pin
12	12468	#12 x 3/4" Screw, S.S.
13	12472	1/4-20 x 5/8" Pan Head Phil.
14	12561	Grip
15	41451	1/4-20" Hex Jam Nut, #18-8
16	12566	Set Collar
17	47751	1/4-20 x 3/16" Set Screw
18	12266	Ice Chute Weldment
19	12077	1/2 od. x 1/4" T-Magnet
20	12115	Switch, Spst. Rocker Type
21	12228	2 1/2" dia. Pulley
22	12229	Screw Block
23	12238	Drive Belt
24	12368	Knob, Handwheel
25	12369	Tube, Handwheel Pivot
26	12384	1/4-20 x 2" Pan Head Ph. M/S
27	12479	Handwheel/Screw Assembly
28	12245	End Plate, Left
29	12246	8" dia. Pulley
30	12258	Left Leg
31	12259	Support, Ratchet Rail
32	12293	Right Leg
33	12383	1/4" Washer, Internal Tooth
34	12415	Magnet Holder

PARTS LIST (continued)

Item No.	Part No.	Description
37	12471	1/4-20 x 1/2" Pan Head Ph.
38	12472	1/4-20 x 5/8" Pan Head Ph.
39	12513	#10-32 x 1/4" Pan Head M/S
40	41013	Knob Door
41	87259	1/4-20" Hex Grip Nut
42	12285	Motor Mount Weldment
43	12286	Main Wrapper Weldment
44	12296	Door Weldment
45	12031	Bushing Shaver Shaft
46	12230	Shaver Head Housing
47	39032	Bushing Cutter Shaft
48	12281	Shaver Blade
49	12231	Shaver Head
50	12418	Drive Shaft
51	12462	1/4 x 1" Spring Pin
52	12567	Ice Pusher
53	12565	Rail, Ice Pusher
54	12461	1/4 x 3/4" Spring Pin
55	12299	Ice Retainer Weldment
56	12386	#4-40 Hex Head Nut S/S
57	12412	Belt Guard Weldment
58	12464	Drain Pan
59	87255	#8-32 x 3/4" Screw
60	12506	18" Blk. Wire Assembly
61	12507	18" Blk. Wire Assembly
62	12508	18" Wht. Wire Assembly
63	12509	.187 x .187 x 3/4" Key
64	12516	Switch Mounting Bracket
65	22038	Lead-in Cord, 15 Amp Plug
66	76026	Strain Relief #SR-6P3-4
67	89128	#8-32 x 1/2" Screw, Round Head Ph.
68	12288	3/4 Hp. Drive Motor
69	39028	Thrust Bearing
70	39029	Thrust Washer
71	12467	#10-32 x 1/2" Hex Head S/S

WIRING DIAGRAM

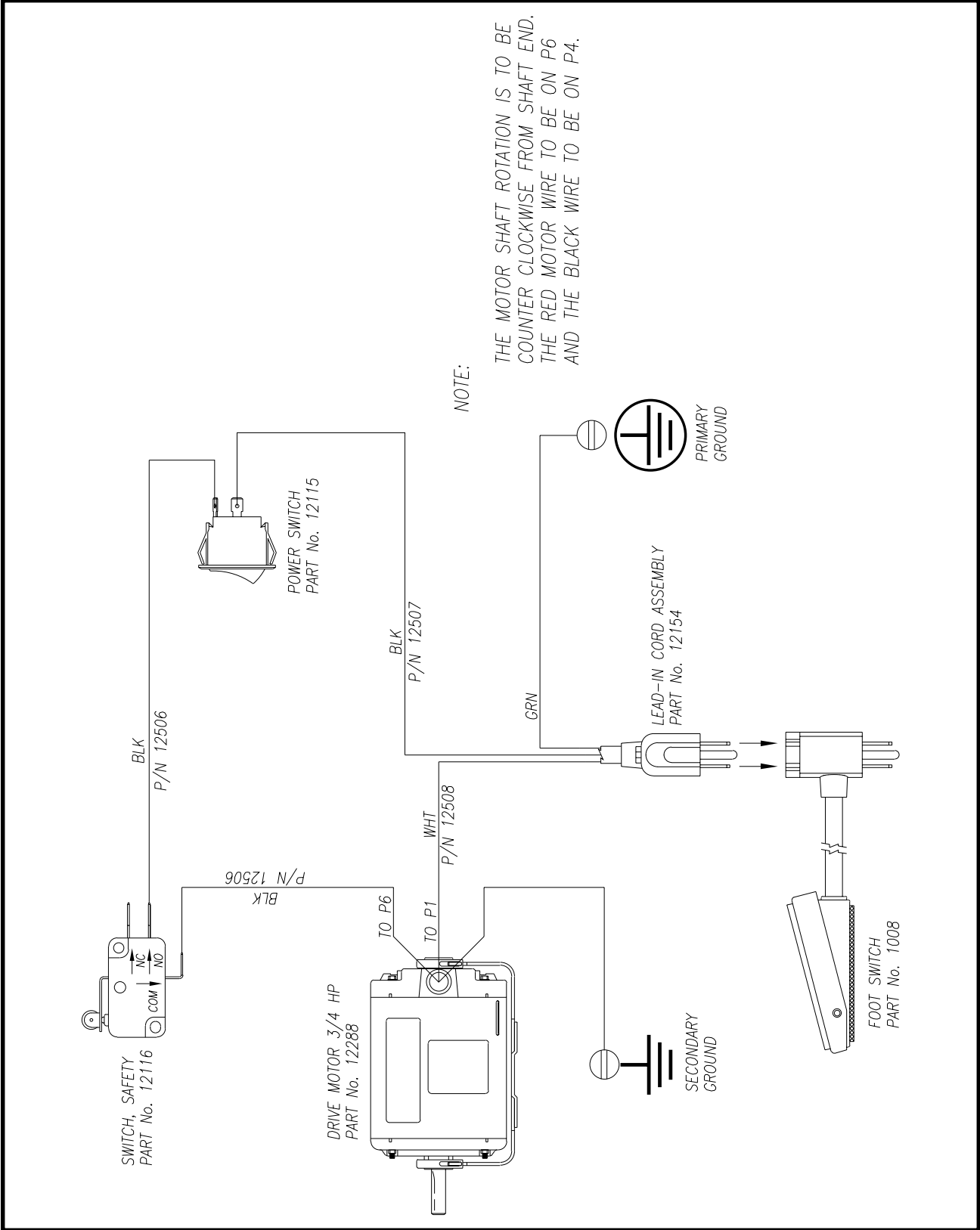

WARRANTY

WE WARRANT to the original purchaser the Gold Medal equipment sold by us to be free from defects in material or workmanship under normal use and service. Our obligation under this warranty shall be limited to the repair or replacement of any defective part for a period of six (6) months from the date of sale to the Original Purchaser with regard to labor and two (2) years with regard to parts and does not cover damage to the equipment caused by accident, alteration, improper use, voltage, abuse, or failure to follow instructions.

THIS WARRANTY IS IN LIEU OF ALL OTHER WARRANTIES EXPRESSED OR IMPLIED, AND OF ALL OTHER OBLIGATIONS OR LIABILITIES ON OUR PART, INCLUDING THE IMPLIED WARRANTY OF MERCHANTABILITY. THERE ARE NO WARRANTIES WHICH EXTEND BEYOND THE DESCRIPTION ON THE FACE HEREOF. We neither assume, nor authorize any other person to assume for us, any other obligation or liability in connection with the sale of said GOLD MEDAL equipment or any part thereof.

The term "Original Purchaser" as used in this warranty shall be deemed to mean that person, firm, association, or corporation who was billed by the GOLD MEDAL PRODUCTS COMPANY, or their authorized distributor for the equipment.

THIS WARRANTY HAS NO EFFECT AND IS VOID UNLESS THE ORIGINAL PURCHASER FIRST CALLS GOLD MEDAL PRODUCTS COMPANY AT 1-800-428-2676 TO DISCUSS WITH OUR SERVICE REPRESENTATIVE THE EQUIPMENT PROBLEM, AND, IF NECESSARY, FOR INSTRUCTIONS CONCERNING THE REPAIR OR REPLACEMENT OF PARTS.

NOTE: This equipment is manufactured and sold for commercial use only.



GOLD MEDAL PRODUCTS COMPANY
10700 Medallion Drive
Cincinnati, OH 45241-4807 USA